



IMPORT VERTRIEBSGESELLSCHAFT MBH

Käthe-Kruse-Str. 5  
26160 Bad Zwischenahn  
Germany

- |                              |                              |
|------------------------------|------------------------------|
| (D) Montageanleitung         | (GB) Assembly Instructions   |
| (NL) Montagehandleiding      | (PL) Instrukcja montażu      |
| (TR) Montaj rehberi          | (RUS) Руководство по монтажу |
| (E) Instrucciones de montaje | (F) Notice de montage        |
| (I) Istruzioni di montaggio  | (CZ) Návod k montáži         |
| (SK) Návod na montáž         | (RO) Instrucțiuni de montaj  |
| (H) Szerelési útmutató       | (SLO) Montaža                |

# YUKON





- |  |  |
|--|--|
| (D) Sicherheits- und Gebrauchshinweise           | (GB) Safety instructions and usage information         |
| (NL) Veiligheids- en gebruiksrichtlijnen         | (PL) Wskazówki dotyczące bezpieczeństwa i eksploatacji |
| (TR) Güvenlik ve Kullanım Talimatları            | (RUS) Инструкции по безопасности и использованию       |
| (E) Instrucciones de seguridad y uso             | (F) Consignes de sécurité et d'utilisation             |
| (I) Istruzioni di sicurezza e utilizzo           | (CZ) Bezpečnostní pokyny a pokyny k použití            |
| (SK) Bezpečnostné pokyny a pokyny pre používanie | (RO) Instrucțiuni de siguranță și utilizare            |
| (H) Biztonsági és használati utasítások          | (SLO) Varnostna opozorila in navodila za uporabo       |

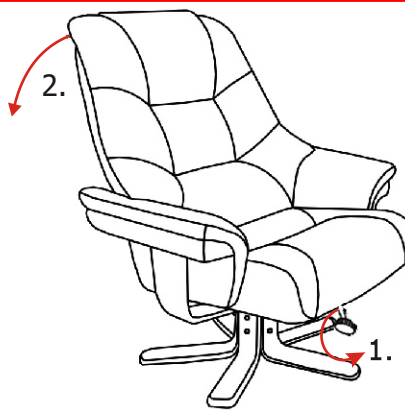

max.  
115kg

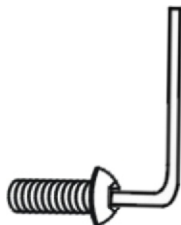



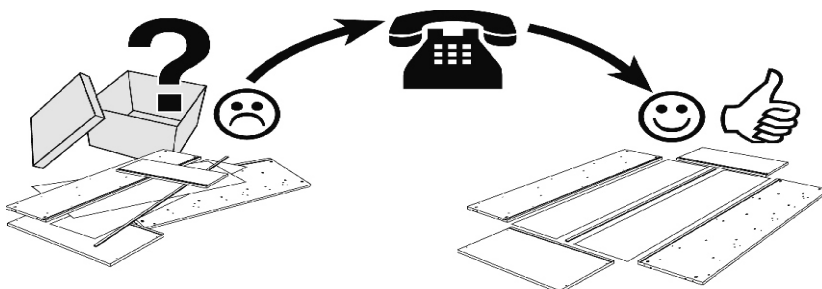

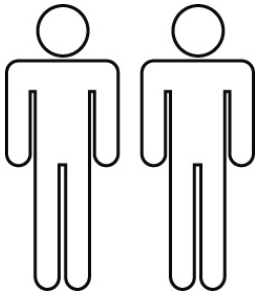

- |  |                                       |
|--|---------------------------------------|
| (D) Nach 5 Wochen nachziehen                   | (F) Resserrer après 5 semaines        |
| (NL) Na 5 weken aandraaien                     | (I) Serrare dopo 5 settimane          |
| (TR) 5 hafta sonra tekrar sıkın                | (CZ) Po 5 týdnech dotáhněte           |
| (GB) Retighten after 5 weeks                   | (SK) Po 5 týždňoch dotiahnuť          |
| (PL) Dokręcić po 5 tygodniach                  | (RO) Strângeți după 5 săptămâni       |
| (RUS) Через 5 недель подтянуть                 | (H) 5 hét elteltével utána kell húzni |
| (SLO) Vija ke je treba po petih tednih priviti | (E) Reapretar después de 5 semanas    |

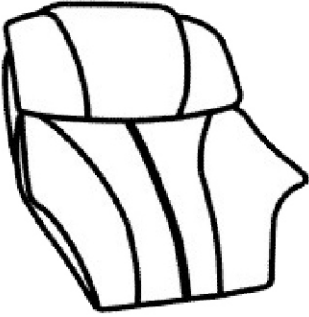

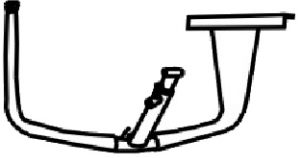
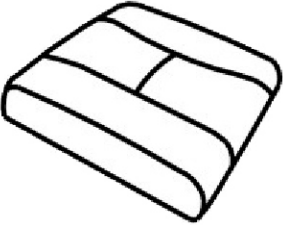

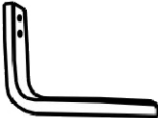
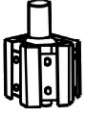
# YUKON

|  |   |  |  |
|--|---|--|--|
| <p><b>1</b></p>    | <p><b>2</b></p>              | <p><b>3</b></p>              | <p><b>4</b></p>   |
| <p><b>5</b></p>  | <p><b>6</b></p>  <p>5x</p> | <p><b>7</b></p>  <p>4x</p> | <p><b>8</b></p>  <p><b>9</b></p>  <p><b>10</b></p>  <p>4x</p> |

(11) 1x (12) 2x (13) 18x (14) 2x (15) 4x (16) 4x (17) 1x (18) 18x (19) 8x (20) 1x (21) 1x

